

FIREGAS

INSTALLATION AND USER'S MANUAL

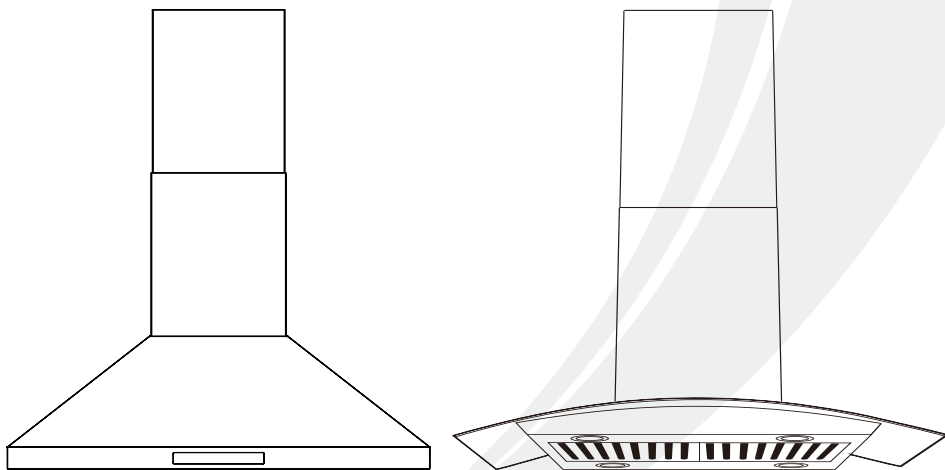

FGS-USI02G75AC
FGS-UBI02G75AC
FGS-USI02G75CC
FGS-UBI02G75CC
FGS-UBI02G90CC
FGS-UBI02G90AC
FGS-USI02G90AC
FGS-USI02G90CC
FGS-USI16G75CC
FGS-UBI17G75CC

For detailed installation and operation videos,
please visit our official website or the FIREGAS YouTube channel.



www.firegaskitchen.com

CONTENT

Parts Diagram	2-3
Installation Instructions	4-5
Duct Connection	6
Installation Instructions	6-7
Filter Installation	8
Grease Cup Installation	8
Using the Controls	9-17
Maintenance	17-19
Trouble-Shooting	20
After-Sales Service	21

NOTE:

You can also watch the installation video on our website under Support > Installation Guide: <http://www.firegaskitchen.com>

Visit our website or subscribe to our YouTube channel (@firegasofficial) for the latest installation and operation videos.

CAUTION:

In humid or rainy weather, remove the carbon filter and run the hood on high speed to help prevent condensation from forming on the surface.

Parts Diagram

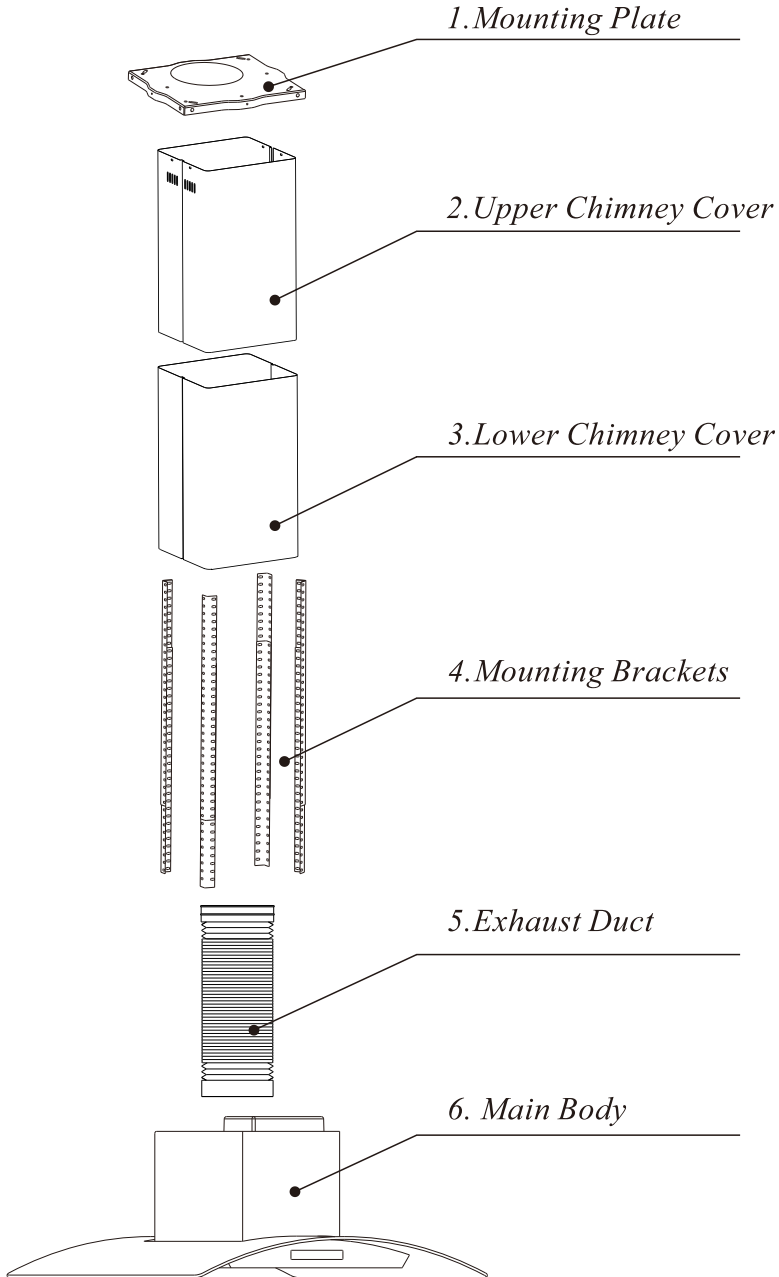

Parts Supplied

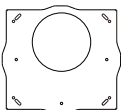

Mounting Plate



Mounting Brackets

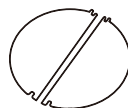

Dampers

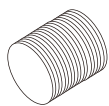

Exhaust Duct

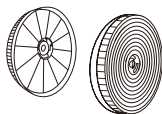

Charcoal Filters
(Please refer to the model list on the last page)



Grease Cup



× 13

St4 × 30



× 13

φ 5 × φ 8



× 8

M6 × 50



× 42

M5 × 10



× 6

St4 × 6



× 3

S-Shaped Hook



× 18

Nut



× 18

Metal Washer

(2 screws extra)

Tools Required



Pencil

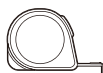

Tape measure

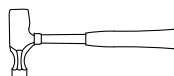

Hammer

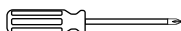

Screwdriver



Level



Electric drill



Aluminum foil tape



Gloves

Installation Instructions

Prepare for installation:

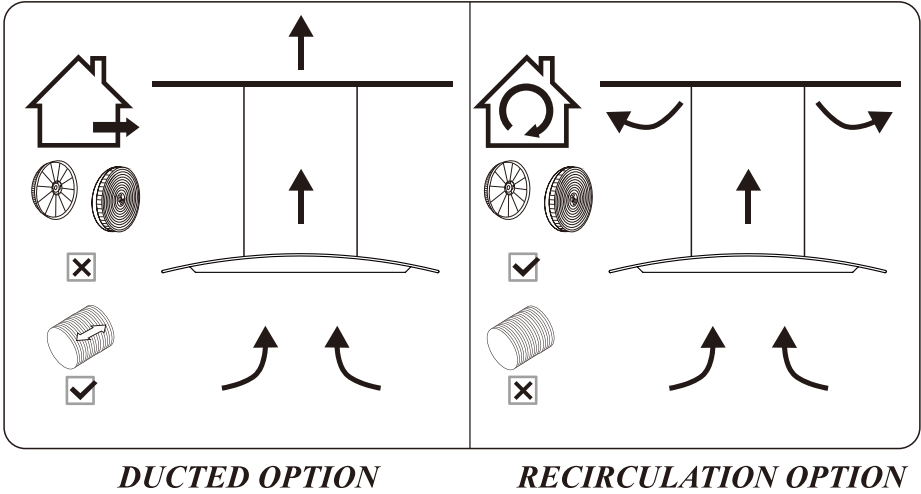

If you have an external vent, you can connect your range hood to it using a duct with a 150 mm (approx. 6") inner diameter, as shown above. If external venting is not available, you can use the recirculation mode with charcoal filters.

Installation Requirements

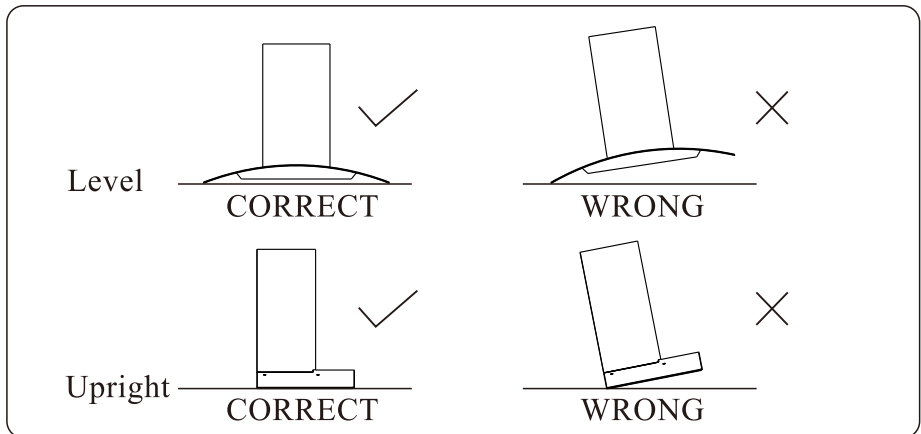

After hanging the unit on the wall, make sure the range hood is straight and level.

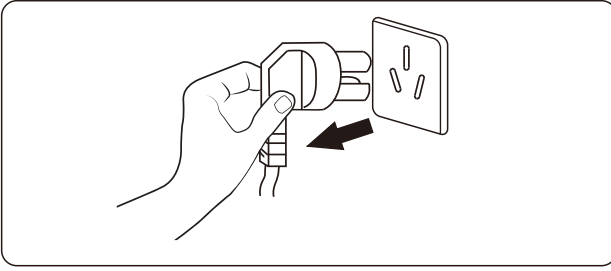

Before installation, turn the unit off and unplug it from the outlet.

installation dimensions

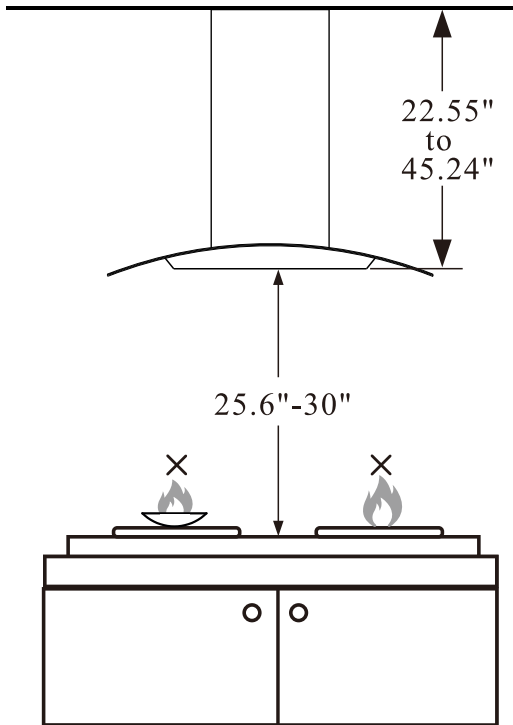

For best results, install the range hood 25.6" – 30" above the cooking surface.

Note: The power cord is 44" long. We do not recommend replacing or shortening it.



Note: Keep open flames away from the range hood.

Duct Connection

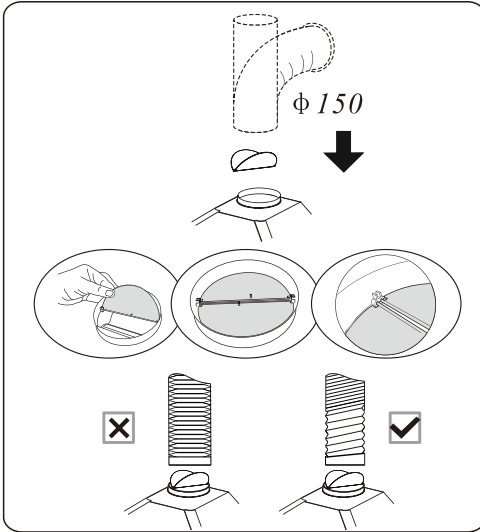

For a 5.91" diameter duct:
install the backdraft damper as
shown and secure the duct.

Ensure the tab on the damper
faces upward.

Make sure the duct near the outlet
is fully extended.

Installation Instructions



Plug in the unit and test that it works before hanging it on the ceiling.

(1) Watch the installation video:



Scan the QR code to watch the step-by-step
installation video.

Quick tip: If you can't scan the QR code, simply
visit our YouTube channel (@firegasofficial) and
search for the video.

(2) Follow the mounting instructions:

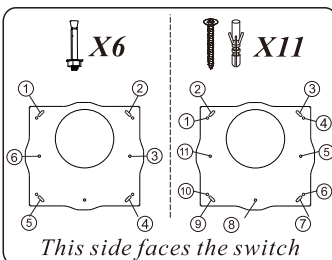

Position the mounting plate on the ceiling
and mark the screw hole locations.
Secure the plate firmly to the ceiling.

- (1) 6 expansion bolts for concrete ceilings.
- (2) 11 ST4x30 screws for wood ceilings.

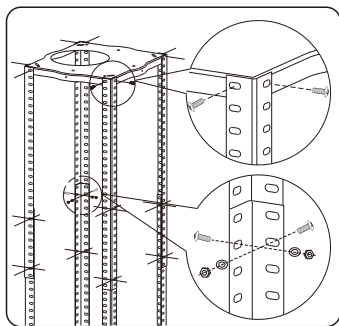

Secure the mounting brackets to the mounting plate using eight M5x10 screws. Extend the mounting brackets to the required height and secure them in position using 16 M5x10 screws, nuts, and metal washers.

IMPORTANT: The mounting brackets must overlap by at least 100 mm (approx. 4").

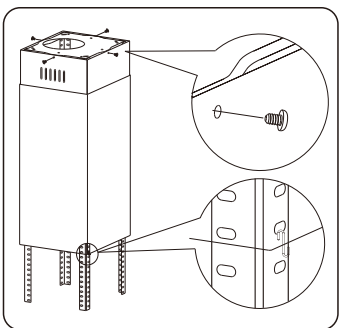

If the range hood will be used in ducted (vented) mode, connect the duct to the ceiling adapter at this point.

Secure the upper chimney cover to the mounting plate using 4 ST4x6 self-tapping screws.

(Slide the lower chimney cover onto the mounting brackets and raise it until it is positioned just below the upper chimney cover.)

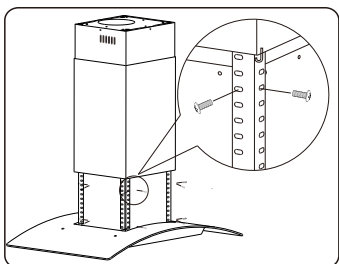

IMPORTANT:

This step **MUST** be completed by two people.

IMPORTANT: The 16 M5 screws **MUST** be fully tightened.

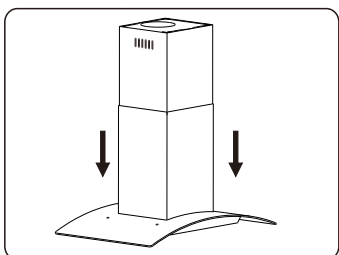

Remove the S-shaped hooks, then slide the lower chimney cover downward until it rests against the main body of the range hood.

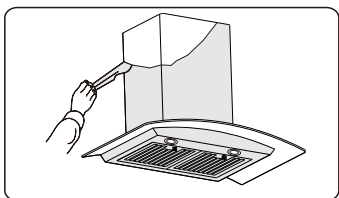

CAUTION:

BEFORE USE

Remove the white/blue protective film from the range hood, chimney covers, and baffle filters (stainless steel surfaces).

Filter Installation

Baffle Filter:

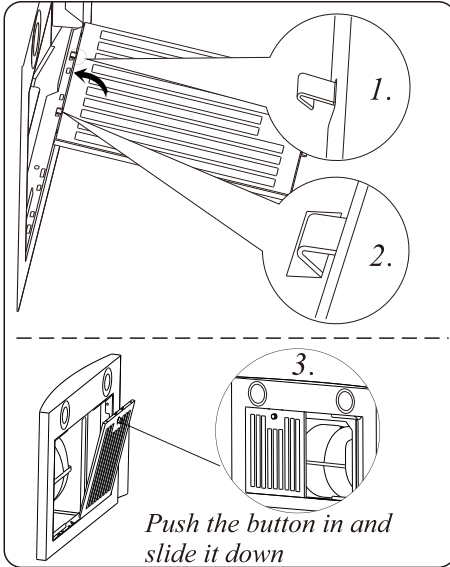

1. Align the filter hooks with the holes on the unit.

2. Lift the filter so the hooks insert into the holes.

3. Secure the filter in place by pressing the button and sliding it down.

Aluminium Filter:

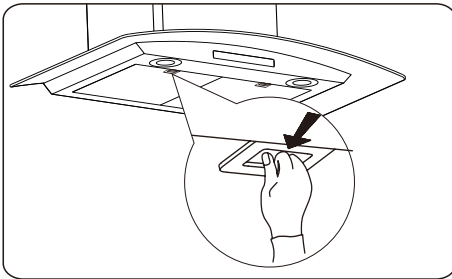

Grease Cup Installation

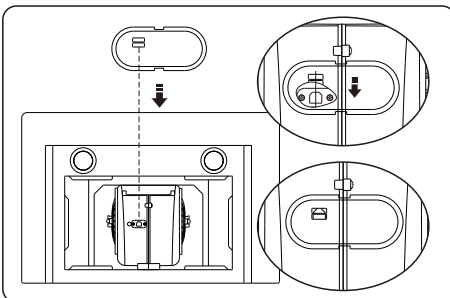

1. Align tabs with slots.





2. Slide in until it clicks.

3. Push up to snap into place.

Using the Controls





Type 1 Push Button Controls



-  **OFF**
Turns the fan off.
-  **Low Speed**
*Starts the fan at low speed.
Ideal for light cooking and simmering.*
-  **Medium Speed**
*Starts the fan at medium speed.
Ideal for everyday cooking.*
-  **High Speed**
*Starts the fan at high speed.
Ideal for heavy smoke or steam.*
-  **Light**
Turns the light on and off.

Type 2 Push Button Controls



-  **OFF**
Turns the fan off.
-  **Low Speed**
*Starts the fan at low speed.
Ideal for light cooking and simmering.*
-  **Medium Speed**
*Starts the fan at medium speed.
Ideal for everyday cooking.*
-  **High Speed**
*Starts the fan at high speed.
Ideal for heavy smoke or steam.*
-  **Light**
Turns the light on and off.

Type 3 Electronic Button Controls



OFF Button

Press to turn the fan off.

Note: While the fan is on, press once for a 1-minute delay, or press twice for instant shut-off.



Lowest Fan Setting



Medium Fan Setting



Highest Fan Setting



Light. *Press to turn light on / off.*

Type 1 Touch Controls



When power is connected, the unit enters standby mode with a beep. The LED screen displays the time in blue, and only the light button is operational. In standby mode, all other icons are off.

- Ⓜ • In standby mode, press the power button for 0.5 seconds to activate the unit.
- In activated mode, the power button illuminates, and the speed buttons become operational.
- Press the power button again to return to standby mode.

- ✪ In activated mode, press the fan button to cycle through the fan speeds: 1 → 2 → 3 → off.

- Ⓜ a. Delay Shut-Off Function
 - When the unit is running, press the timer button to activate the delay timer.
 - The default delay time is 3 minutes. While the timer button is flashing, press it to increase the delay time by 1 minute per press (adjustable from 1 to 60 minutes).
 - If no button is pressed for 10 seconds, the countdown begins. The unit will turn off automatically when the countdown finishes.
 - During the last 3 seconds, the unit emits a beep. To cancel the delay, press the timer button again.

- b. Clock Setting Function
 - In standby or activated mode, press and hold the timer button for 1 second to enter clock setting mode. The time on the LED screen will flash.
 - Press the timer button to increase the hour, and press the light button to increase the minutes.
 - After setting, press the timer button again or wait 10 seconds to confirm.

- ☀ Press the light button to turn the light on or off.

Type 2 Touch Controls



Quick tip: For a detailed operation video, search “FIREGAS island range hood Type 2 touch controls tutorial” on YouTube.

Initial Startup

When the range hood is powered on, the indicator flashes briefly and then goes off after 1 second. The display turns white momentarily, then shows 12:00 and enters standby mode.

⏻ Power Button

Press to turn the hood on or off.

Delay Timer

① *Setting the Delay Time:*

- *Press and hold the Power button ⏻ for 3 seconds. The display will show “5:00” and start flashing.*
- *Use + or - to set the desired shut-off time (1–60 minutes). Hold down either button for fast scrolling.*
- *To save and exit, press the Power button ⏻ once, or simply wait 10 seconds—the setting will be saved automatically.*



② *Starting the Delay Shut-Off:*

- *Press the Power button ⏻ to activate the timer. The indicator light will turn on, and the countdown will begin (default: 5 minutes).*
- *Press the Power button ⏻ again to turn the device off immediately.*
- *To cancel the timer without turning off the device, press and hold the Power button ⏻ for 3 seconds.*

Lighting & Clock Settings

Light ON/OFF: Press the Light button  to turn the light on or off.

Set the Clock:

- *Press and hold the Lighting button  for 3 seconds. All indicators will flash, and the display will show the hour value flashing.*
- *Press + or - to adjust the hour, then press the Lighting button  to confirm and switch to minute adjustment.*
- *Press + or - to adjust the minutes.*
- *To save and exit, press the Lighting button  again, or simply wait 10 seconds for automatic confirmation.*

Gesture Controls

When the hood is off (standby): Swipe your hand from left to right across the sensor to cycle the motor speed through levels 1→2→3→1 (in a loop).

When the hood is on or the motor is running:

- *Swipe from right to left to start a 3-minute countdown timer.*
- *Swipe from right to left again to turn the device off immediately.*

Note: The effective sensing distance is approximately 11–15 cm from the sensor.

Type 3 Touch Controls





Quick tip: For a detailed operation video, search “FIREGAS island range hood Type 3 touch controls tutorial” on YouTube.

Power Button

- When the hood is off, press this button to turn it on at low speed.
- When the hood is running, press this button to turn it off.
(Note: The light is not affected by this button.)



Delay Timer

With the hood on, press and hold the Light button  for 2 seconds to activate the 5-minute delay timer. The display will blink, and the fan will shut off automatically when the time runs out. To cancel, press the Light button  again.



Light Button

When the hood is off (standby), press this button to turn the light on or off.

Speed Down (-)

Press to decrease the fan speed by one level.

Speed Up (+)

Press to increase the fan speed by one level.

Gesture Control

Left-to-Right Swipe (when the hood is off):

- 1st swipe: Turns on the hood at speed 1 and turns on the light.
- 2nd swipe: Increases to speed 2.
- 3rd swipe: Increases to speed 3. (The speed does not cycle; it stays at 3.)

Right-to-Left Swipe (when the hood is on):

- Swipe right to left to start a 3-minute delay timer. The display will blink during the countdown, and the hood will shut off automatically after 3 minutes.
- To cancel the timer and turn the hood off immediately, swipe right to left again while the timer is running.





Note: The effective sensing distance is approximately 11–15 cm from the sensor.

Type 4 Touch Controls



Quick tip: For a detailed operation video, search “FIREGAS island range hood Type 4 touch controls tutorial” on YouTube.

Fan Controls

- Press power button  to turn on the hood. The unit will enter Standby mode.
- Use +  or -  to adjust fan speed.
- When the fan is at its lowest speed, press –  to turn it off.

Light Control

Tap the light button  to turn the light on or off.

Delay Timer Settings





Setting the Delay Time:

While the hood is running, press power button  once to start a 5-minute countdown. The display shows 05:00 and the hood will turn off automatically when time expires.

Quick tip: (a). Press Power button  again to cancel the timer and shut the hood off immediately.

(b). You can still adjust fan speed during the countdown.

Using the Delay Timer:

- With the hood off, press and hold power button  for 2 seconds.
- The display flashes 05:00.
- Press the  and  button to adjust the time. (Press and hold for continuous fast adjustment.)
- The timer can be set from 1 to 60 minutes (no wrap).
- Press power button  to save and exit. Or, just wait 10 seconds for auto-save.

Important: If gesture control is enabled, the delay time is fixed at 3 minutes, overriding your custom setting.

Setting the Clock

- With the hood off, press and hold the light button ☺ for 2 seconds. The +, -, and Light touch controls will illuminate.
- The hour digits will flash. Tap the ⊕ or ⊖ button to adjust the hour (touch and hold for fast scrolling). Note: The clock uses a 12-hour format.
- Tap the light button ☺ again to confirm the hour. The minute digits will then flash.
- Tap the ⊕ or ⊖ button to adjust the minutes (press and hold for fast adjustment).
- Tap light button ☺ to confirm, or simply wait 10 seconds for the settings to auto-save.

Quick tip: For a step-by-step video on setting the clock, just search "How to set the clock on a FIREGAS island range hood" on YouTube.

Gesture Controls

① *Power & Speed Control: When the fan is off, swipe your hand left-to-right over the panel to turn it on to Low. Keep swiping the same direction to cycle through speeds: Low → Medium → High → Low.*

② *3-Minute Auto-Off Timer: While running, swipe right-to-left to set a 3-minute timer. The fan will count down and shut off automatically when the timer ends.*

To cancel early: Just swipe right-to-left again during the countdown—the fan will stop immediately.

Note: For the most responsive control, keep your hand 4–6 inches (11–15 cm) from the control panel.

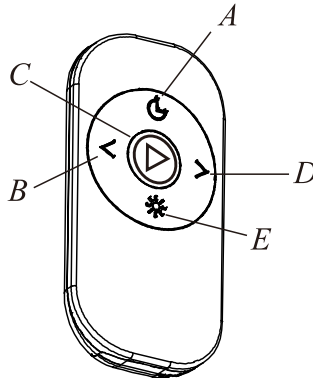

Remote Control Operation

A.Delay Timer: With the fan running, press this button to start the 5-minute auto shut-off timer. Press it again to stop the countdown. (Note: The delay time is fixed and cannot be changed with the remote.)

B.Speed Down: Lowers fan speed.

C.Power: Turns hood on/off.

D.Speed Up: Raises fan speed.

E.Light: Turns light on/off.

Maintenance

Before cleaning, turn the hood off and unplug it.

I.Regular Cleaning

Use a soft cloth dampened with warm, mild soapy water or an all-purpose household cleaner. Never use steel wool, scouring pads, harsh chemicals, abrasive materials, or stiff-bristled brushes to clean the unit.

II.LED Light Replacement

Turn the unit off and unplug it before servicing.

CAUTION: THE LAMP UNIT MAY BE HOT!

Allow the unit to cool completely before proceeding. Ensure the unit is turned off and unplugged before attempting to replace the LED lamps.

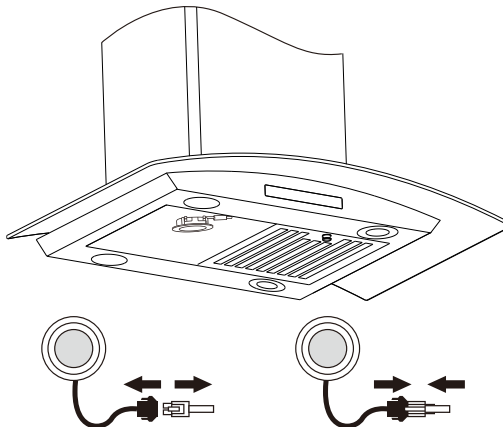

III. Grease Filter Cleaning

We recommend cleaning the grease filters once a month.

To remove: press the latch tab on the handle and pull the filter straight down.

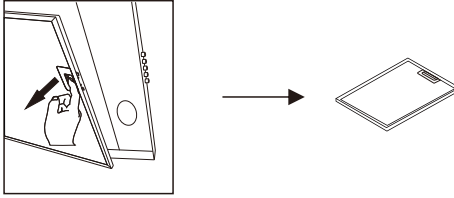

To clean: soak the filter in hot, soapy water for 1 hour, then rinse and let it air-dry completely. For dishwasher use, place the filter vertically in the rack for better cleaning coverage.

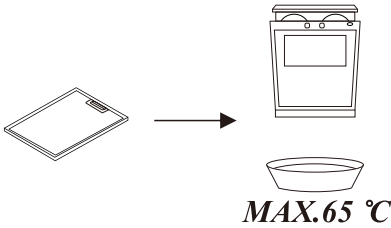

To reinstall: slide the dry filter back into the slot and push upward until you hear a click, confirming it is secured.

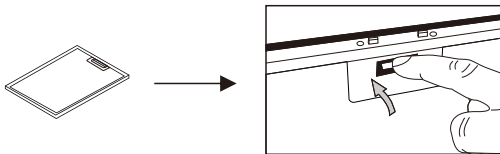

IV. Charcoal Filter Replacement

Replace the charcoal filters every 3 months. Depending on your cooking frequency and the types of food you prepare, the interval may be shorter or longer.

The charcoal filters are located on both sides of the blower. You must remove the grease filters first to access the charcoal filters.

To remove the old filter: twist it counter-clockwise to unlock, then pull it out of the housing.

To install the new filter: insert it into the slot and twist it clockwise until it locks firmly in place. Repeat the same step for the filter on the opposite side.

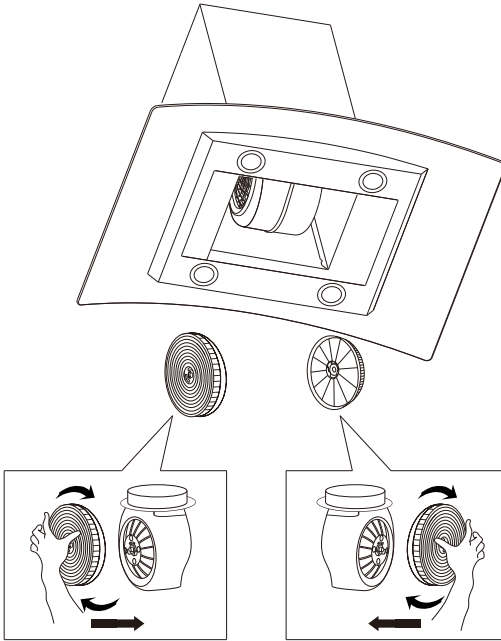

WARNING

Ensure the filter is securely locked in place. If not, it may become loose during use, causing excessive noise and a safety hazard.

NOTE:

Please note that the charcoal filter will reduce the range hood's airflow.

Trouble-Shooting

<i>Issue</i>	<i>Possible Cause</i>	<i>Solution</i>
<i>Light is on, but fan does not operate.</i>	<i>The fan blade is obstructed / jammed.</i>	<i>Turn the unit off and contact qualified service personnel for repair. Do not attempt to fix it yourself.</i>
	<i>The motor is defective.</i>	
<i>Neither the light nor the fan works.</i>	<i>The LED light is burnt out.</i>	<i>Replace the LED light with one of the correct rating.</i>
	<i>The power cord is loose.</i>	<i>Unplug and securely plug the power cord back into the outlet.</i>
<i>Excessive vibration during operation.</i>	<i>The fan blade is damaged or unbalanced.</i>	<i>Turn off the unit and have it inspected by a qualified technician.</i>
	<i>The fan motor is not securely mounted.</i>	
	<i>The unit is not properly seated on the mounting bracket.</i>	<i>Remove the unit and check that the bracket is correctly aligned and securely installed.</i>
<i>Poor suction / airflow performance.</i>	<i>The distance between the unit and the cooktop is too large.</i>	<i>Readjust the installation height to between 25.6" and 30" (65–76 cm).</i>

After-Sales Service

If you require assistance or have any questions regarding your range hood, please contact our customer service team. We are committed to providing you with reliable and timely support.

Contact Information

Email: support01@firegaskitchen.com

Website: www.firegaskitchen.com

To help us handle your request more efficiently, please provide the following information when contacting us:

- *Your order number and product model*
- *A detailed description of the issue*
- *Photos or videos clearly showing the problem*

Our customer service team will review your request and strive to respond to your email within 24 hours.

Installation & Operation Videos

To watch installation or operation videos for this range hood, please visit our official website or search “FIREGAS + model number” on YouTube or TikTok.

We regularly post tutorial videos on how to install and operate your range hood. Subscribe to our YouTube channel (@firegasofficial) for updates.

Model List

<i>Range Hood Model No.</i>	<i>Charcoal Filter Model No.:</i>
<i>FGS-USI02G75AC</i> <i>FGS-UBI02G75AC</i> <i>FGS-USI02G75CC</i> <i>FGS-UBI02G75CC</i> <i>FGS-UBI02G90CC</i> <i>FGS-UBI02G90AC</i> <i>FGS-USI02G90AC</i> <i>FGS-USI02G90CC</i> <i>FGS-USI16G75CC</i> <i>FGS-UBI17G75CC</i>	<i>CC170</i>

If you need a replacement charcoal filter, you can find it on Amazon by searching for “FIREGAS CC 170”.

FIREGAS

Thanks for reading.
We wish you a lot of fun cooking

